

BB091271MDX Twin Fan Multifunction 90 cm Built-in Oven



**Main Cavity
Gross Volume**
127 L

**Number of
Functions**
8

Oven Feature
Twin Fan

**Cleaning
Feature**
Catalytic Panels

Main Features

Oven features:	Twin Fan Multifunctional Cooking
Gross Volume:	127 L
Net Volume:	111 L
Number of Shelf Positions:	5 Levels
Telescopic Shelving:	1 Levels Full Extension
Display/Control Type:	LED Touch Control
Display Brightness Adjustment:	Yes
Cooling Fan:	Yes
Key Lock:	Yes
Max. Temperature:	280°C
Total Power Consumption:	3.1 kW
Fuse:	13.47 A (Hardwired)

Design

Colour:	Black Glass, Dark Stainless Steel
Illumination:	2 x Rear
Soft Close Door:	Yes
Layers of Door Glass:	3
Inner Door Type:	Full Glass (removable)

Cleaning

Catalytic Panels:	Side & Back Walls
Easy Clean Glass Door:	Yes
Simple Steam Cleaning:	Yes

Accessories

Cooking Tray (Full Size):	1
Grill Insert:	1
Wire Shelves:	2

Functions

Number of Functions	8
3D Function	Conventional Cooking
Fan Assisted	Bottom Heating
Fan Heating	Electric Grill
Low Grill with Fan	Defrost

Dimensions & Weights

Unpacked Height:	595 mm
Unpacked Width:	894 mm
Unpacked Depth:	547 mm
Unpacked Weight:	32.0 kg
Built-in dimensions (Cabinet): See Diagram overpage	
Height:	590 mm
Width:	860 mm
Depth:	550 mm
Built-in dimensions (Under Bench): See Diagram overpage	
Height:	600 mm
Width:	860 mm
Depth:	550 mm
Packaged Height:	590 mm
Packaged Width:	896 mm
Packaged Depth:	660 mm
Packaged Weight:	36.0 kg

Sku:	7786584328
Ean Code:	8690842385971
Manufacturers Warranty:	2 Years + 3 Years by Registration
Launch Date:	May 2021

BB091271MDX

Twin Fan Multifunction 90 cm Built-In Oven



Twin Fan - With Beko's TwinFan technology, you can now cook large portions in no time. By spreading heat evenly throughout the oven, the dual fans provide better air circulation, giving you faster pre-heating and cooking time compared to single fan oven.



Extra Large Capacity- Beko 90cm oven with its 127L gross capacity means you can cook lots of food in one go. You can even get 5 shelves of food cooked perfectly even at the same time.

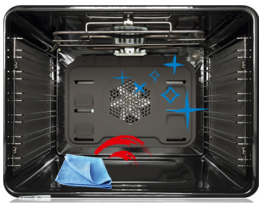

Catalytic Panels & Easy Clean Door - Offering an easy cleaning solution, the interior side & back has catalytic panels, absorbing grease & dirt. Cleaning your oven's door has never been easier with Beko's easy-to-remove inner glass door. Free of bolts you can comfortably slide the glass door out to help you clean even those hard-to-reach places.

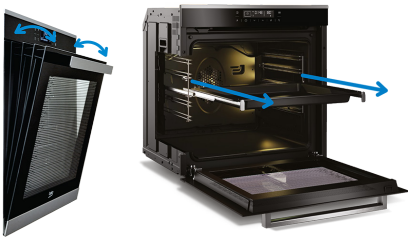

Soft Close Door & Fully Extendable Telescopic Shelf- If you find yourself struggling to get that heavy dish out of the oven, Telescopic Shelves will make your life easier. It's runner system lets you pull the shelf all the way out of the oven while supporting your dish and thanks to the clever hinges, the door softly closes with grace, elegance and ssshhh.

Cabinet Dimensions

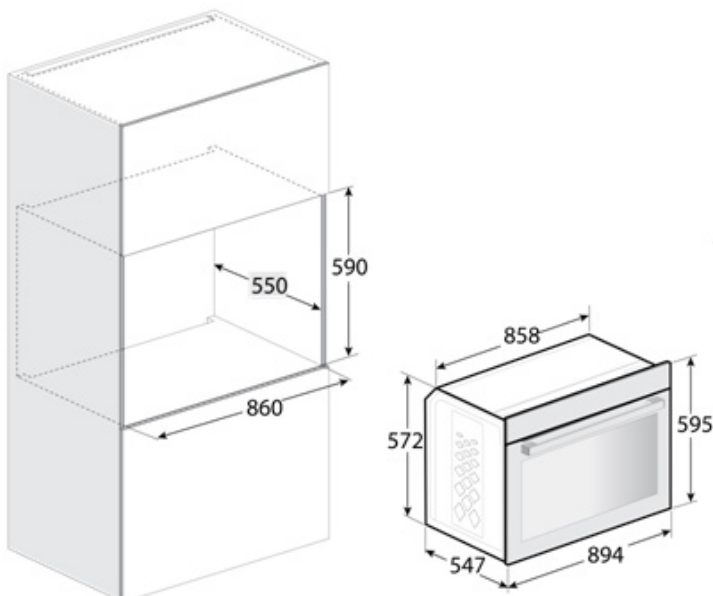

Under Bench Dimensions

